

Mary



Mary



Comfort

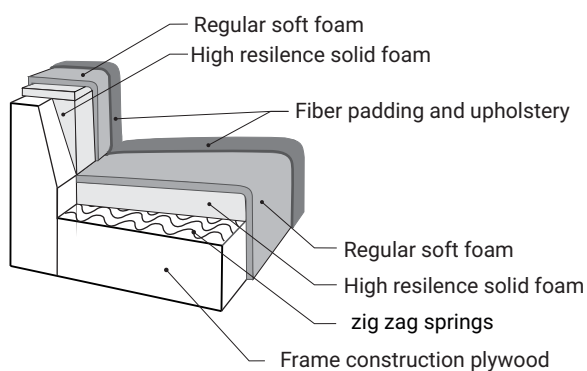

Extra dimensions

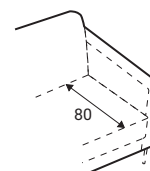

depth of seat

Legs



Foot P03, H-50
Black plastic

Accessories

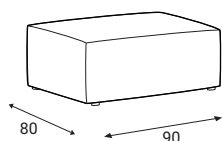

Footstool

Set of decorative pillows
(Sold Separately)

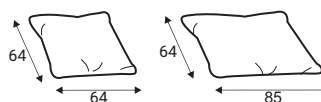

Pillow 3 x D2

Pillow 2 x D4

Set of decorative pillows
(Sold Separately)

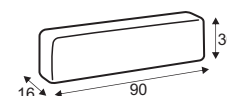

Back cushion 3 x 90

Standard sets

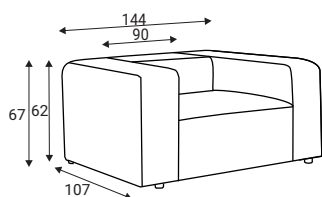

1.5S - A25+90+A25

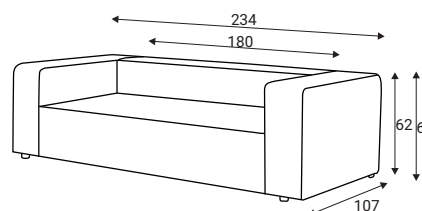

3S - A25+180+A25

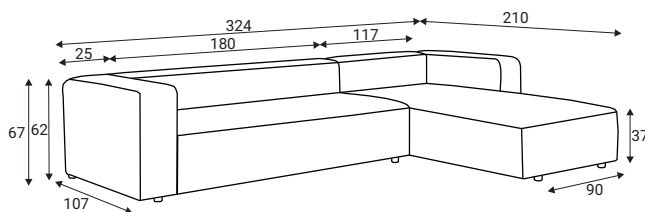

1XR - A25+180+D90XS+A25

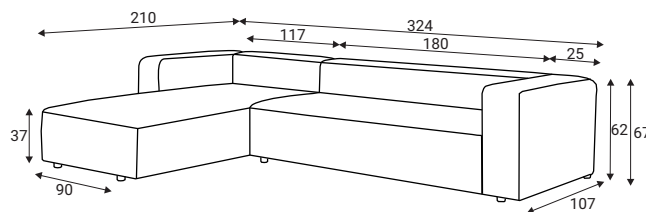

1XL - A25+D90XS+180+A25

Furniture features in symbols



- Seat and back cushions are fixed to the frame.



- Fabric