

Motive



GRAFU
SINCE 1997

Motive



Comfort

Extra dimensions

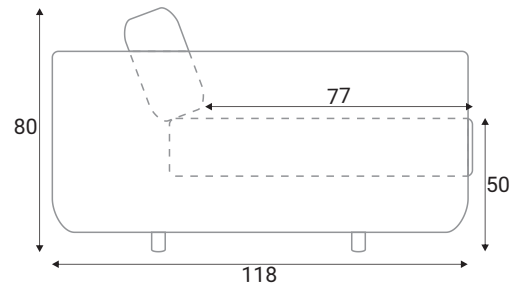
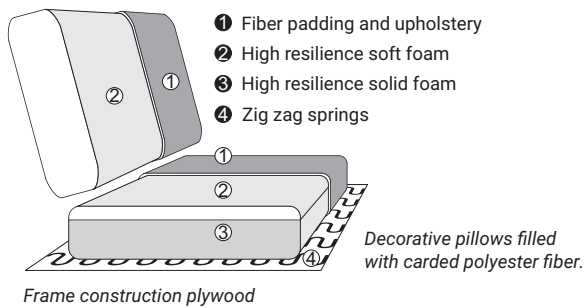

Legs

Armrests



W16, Solid wood, painted black



W21, Solid wood, painted black



Accessories

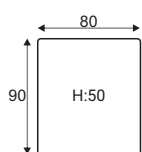

Footstool
80x90

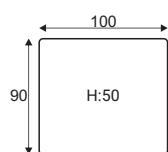

Footstool
100x90

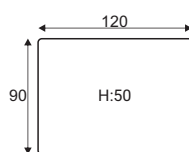

Footstool
120x90

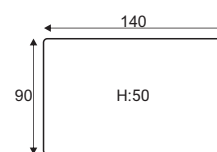

Footstool
140x90

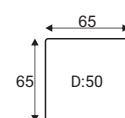

Deco pillow
D18

Motive



Modules

Dimensions with A23 armrest and W16 legs

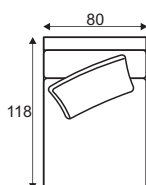

80 part

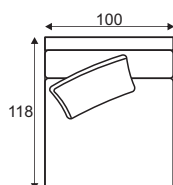

100 part

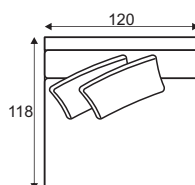

120 part

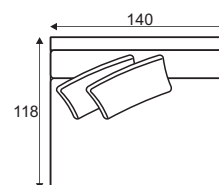

140 part

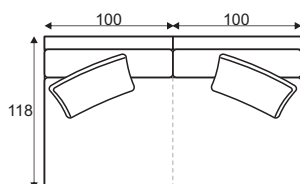

(200) 100+100

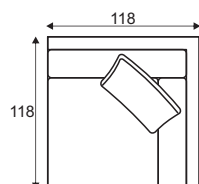

Corner part

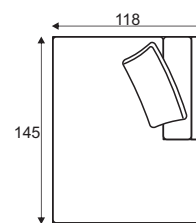

Open end

Standard sets

Dimensions with A23 armrest and W16 legs

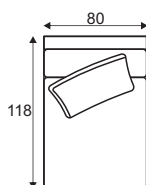

80FP - seater

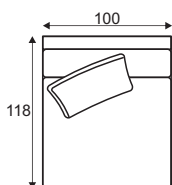

100FP - seater

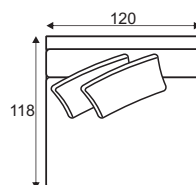

120FP - seater

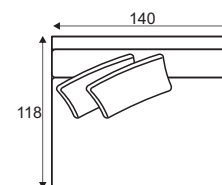

140FP - seater

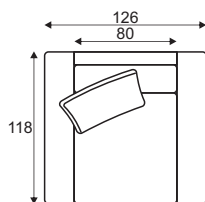

1S - seater

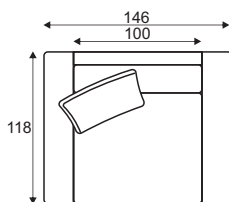

1,3S - seater

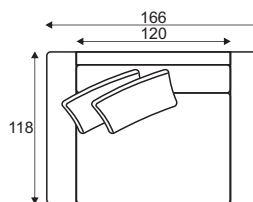

1,6S - seater

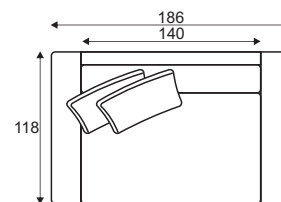

2S - seater

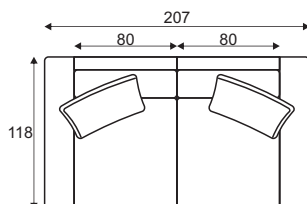

2,5S - seater

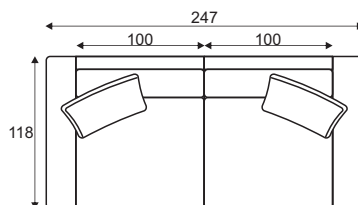

3S - seater

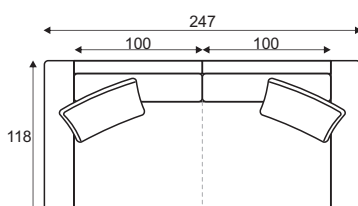

3S - seater (200)

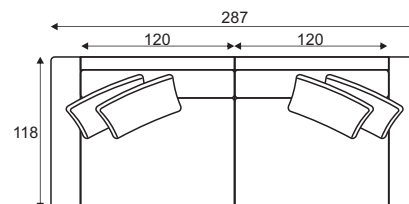

3,5S - seater

GRAFU reserves the right to change construction of products and components used due to improving durability of product and customer satisfaction without any further notice. Upholstered furniture is handmade using soft materials there fore measurements may vary up to +/- 3cm. Slight colour variations may occur between production batches. For technological reasons variations in color shades are acceptable.

Motive



Standard sets

Dimensions with A23 armrest and W16 legs

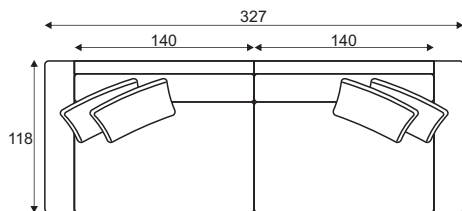

4S - seater

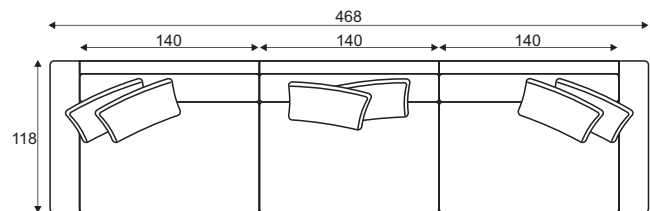

6S - seater

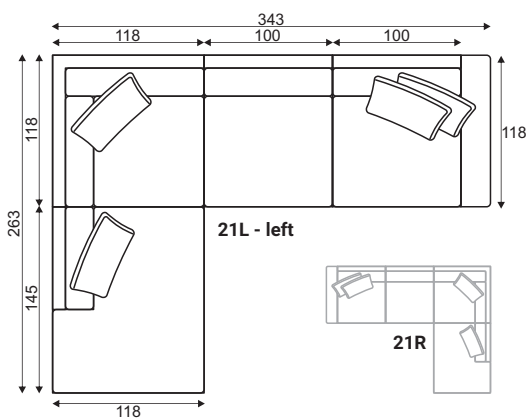

21L - left

21R

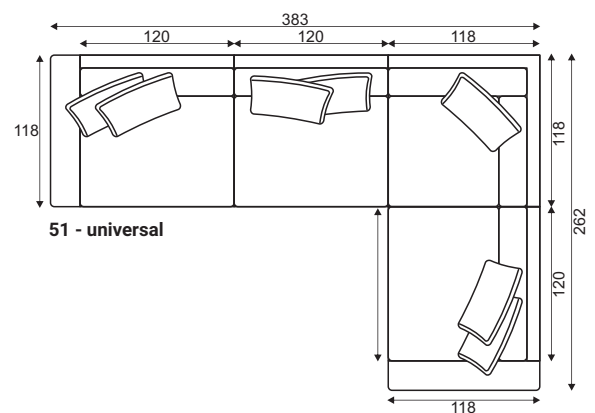

51 - universal

Furniture features in symbols



- Seat and back cushions are loose from the frame



- Removable cover for loose cushions
(For maintenance please check fabric information.)



- Fabric



- Modular system

GRAFU reserves the right to change construction of products and components used due to improving durability of product and customer satisfaction without any further notice. Upholstered furniture is handmade using soft materials there fore measurements may vary up to +/- 3cm. Slight colour variations may occur between production batches. For technological reasons variations in color shades are acceptable.