

# Town



**GRAFU**  
SINCE 1997

# Town



## Comfort

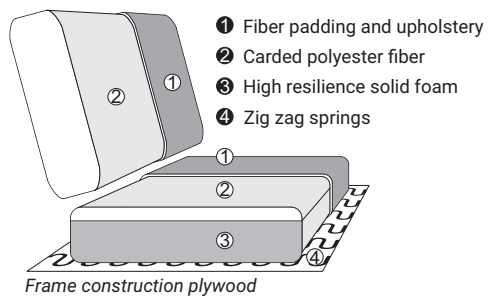

## Extra dimensions

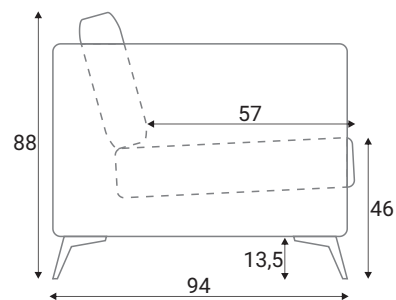

## Legs



## Accessories

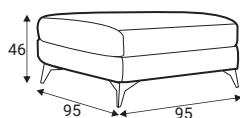

Footstool 95x95

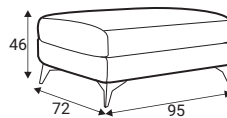

Footstool 72x95

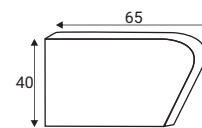

Armrest cover

## Modules

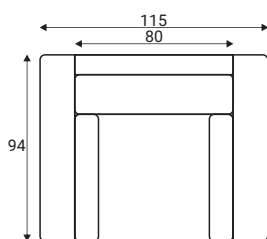

1S - seater

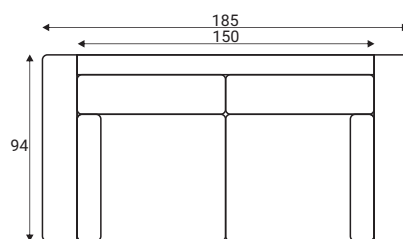

2S - seater

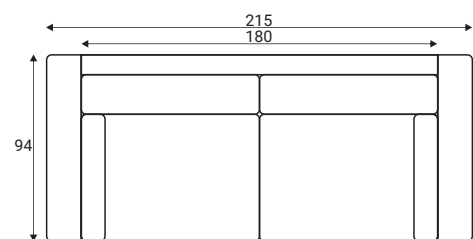

3S - seater

## Furniture features in symbols



- Seat and back cushions are loose from the frame.



- Fabric



- Removable cover for loose cushions.  
(For maintenance please check fabric information.)