

# *Harrison, Hampton*

---

## *Modern / II*

HAFELE

BLUM

TIP-ON



# Harrison



## Specification

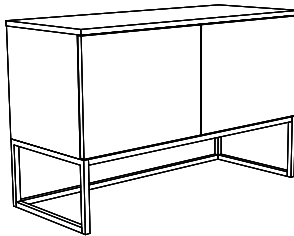

- Body 19 mm Oak veneered MDF
- Top 26 mm Oak veneered MDF
- Metal frame 20x20x1,5 mm square tube.

## Possible colours



White pigment



Mocca

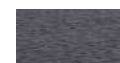

Black wood look

We reserve the right to have deviations of colour white pigment due for variations in the types of wood used.

## Articles

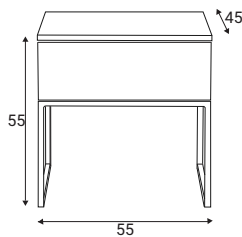

Cabinet with drawer

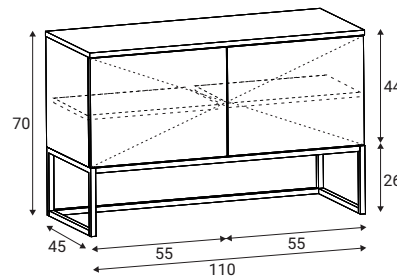

Cabinet 2 doors

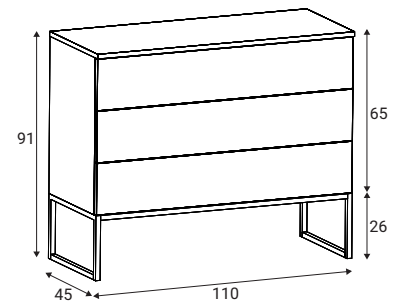

Cabinet 3 drawers 110

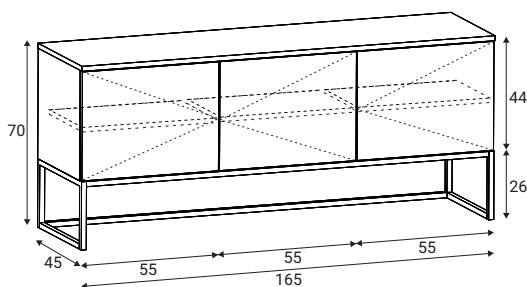

Cabinet 3 doors

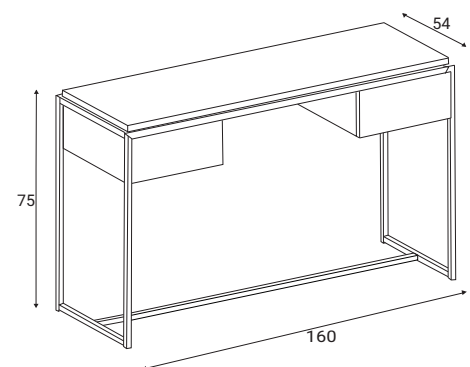

Desk with drawers 160x54

# Harrison - Hampton Modern



## Specification

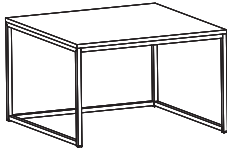

- Body 19 mm Oak veneered MDF
- Top 26 mm Oak veneered MDF
- Metal frame 20x20x1,5 mm square tube.

## Possible colours

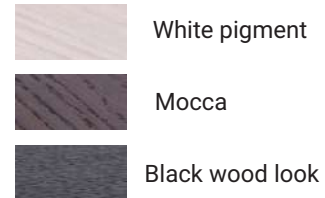

We reserve the right to have deviations of colour white pigment due for variations in the types of wood used.

## Articles of Harrison

### Fits together

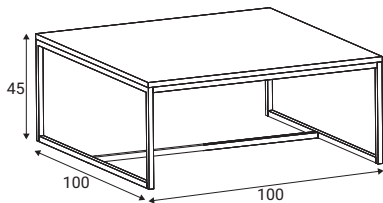

Coffee table 100x100, H - 44.5

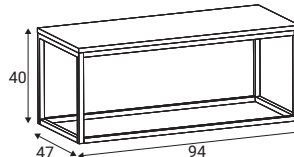

Coffee table 94x47, H - 40

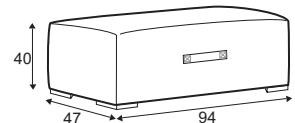

Footstool 94x47, H-40

## Articles of Hampton Modern

## Hampton Modern

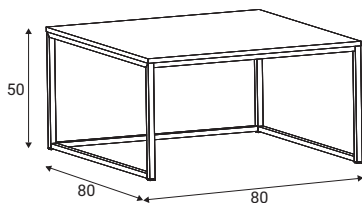

Coffee table 80x80, H-50

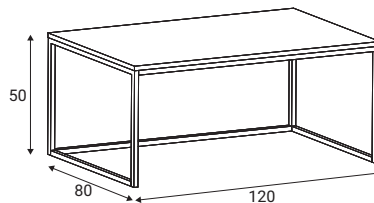

Coffee table 120x80, H-50

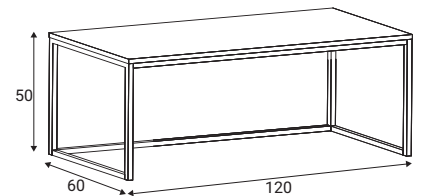

Coffee table 120x60, H-50

## Furniture features in symbols

**BLUM** - Hinges and drawer runners from BLUM



- Oak veneered MDF.

**TIP-ON** - TIP-ON opening system for handle-less doors or drawers

GRAFU reserves the right to change construction of products and components used due to improving durability of product and customer satisfaction without any further notice. Upholstered furniture is handmade using soft materials there fore measurements may vary up to +/- 3cm. Slight colour variations may occur between production batches. For technological reasons variations in color shades are acceptable.

# Hampton Modern II

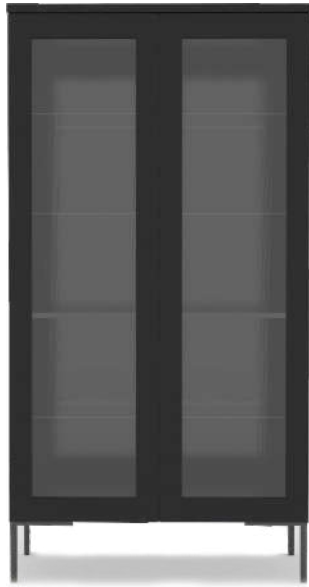

## Specification

## Possible colours

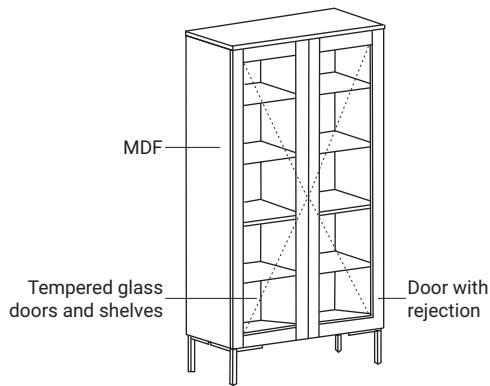

Black wood look

We reserve the right to have deviations of colour white pigment due for variations in the types of wood used.

## Articles

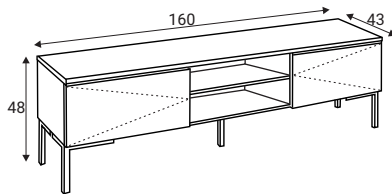

TV table

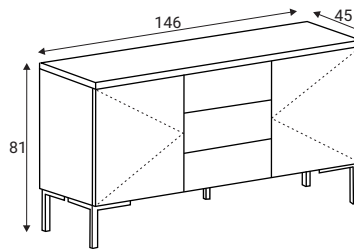

Cabinet with 2 doors and 3 drawers

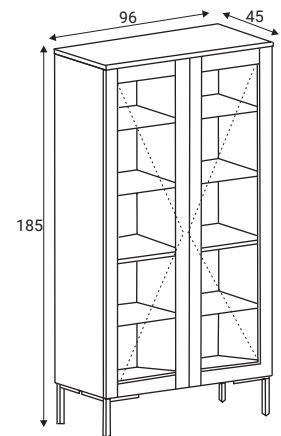

Vitrin with 2 doors

## Furniture features in symbols

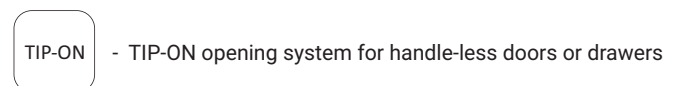
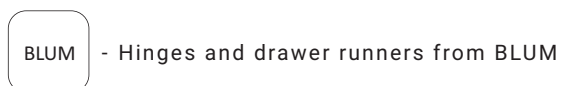

GRAFU reserves the right to change construction of products and components used due to improving durability of product and customer satisfaction without any further notice. Upholstered furniture is handmade using soft materials there fore measurements may vary up to +/- 3cm. Slight colour variations may occur between production batches. For technological reasons variations in color shades are acceptable.